

Universal 420/520 High Capacity

ROTARY POSITIVE DISPLACEMENT PUMPS



For more than half a century, Waukesha Cherry-Burrell has been a leader in the design, manufacturing and application of external circumferential, piston-type, positive displacement pumps. Waukesha positive displacement pumps are in service around the world in food, dairy, canning, bakery, beverage and pharmaceutical processing, as well as challenging chemical and industrial applications.

SPX FLOW, Inc. (NYSE:FLOW) is a leading manufacturer of innovative flow technologies, many of which help define the industry standard in the market segments they serve. From its headquarters in Charlotte, North Carolina, it operates a sales and support network, centers of manufacturing excellence, and advanced engineering facilities, throughout the world. Its cutting-edge flow components and process equipment portfolio includes a wide range of pumps, valves, heat exchangers, mixers, homogenizers, separators, filters, UHT, and drying technology that meet many application needs. Its expert engineering capability also makes it a premium supplier of customized solutions and complete, turn-key packages to meet the most exacting of installation demands.

Incorporating many leading brands, SPX FLOW has a long history of serving the food and beverage, power and energy, and industrial market sectors. Its designs and engineered solutions help customers drive efficiency and productivity, increase quality and reliability, and meet the latest regulatory demands. In-depth understanding of applications and processes, state-of-the-art Innovation Centers, and advanced pilot/testing technology further assist in optimizing processes and reducing timescales to reliably meet production targets.

To learn more about SPX FLOW capabilities, its latest technology innovations and complete service offerings, please visit www.spxflow.com.

High-Volume Capacity with the Reliability of a Waukesha Cherry-Burrell

Users of Waukesha positive displacement pumps benefit from decades of continuing product improvement. Steady advances in design, metallurgy and fabrication techniques have yielded progressively higher levels of performance and service life. Over the years, this tradition has overcome countless pumping challenges — from high-viscosity to abrasiveness to metering accuracy.

The 420 & 520 models overcome a prodigious challenge: reliable and accurate pumping at high-volume capacities.

Every revolution of the Model 420 pumps more than 1.6 gallons (6 liters) of product. Model 520, more than 2.3 gallons (8.7 liters).

Significantly, Models 420 & 520 are not just scaled up Waukesha positive displacement pumps. They incorporate fresh design approaches that simplify installation, ease pump maintenance and extend pump life.

FEATURES AND BENEFITS

Sanitation Features

- Rotor/shaft connection sealed from product zone
- Sideway mounting capability for better draining
- 316L pump body and cover
- Exclusive, non-galling Waukesha “88” alloy rotors standard; permits running at tighter clearances and higher efficiencies; 316 stainless also available
- Mechanical seals standard
- Aseptic model option available

Long-life Features

- Large diameter 17-4 PH shafts for greater strength.
- Heavy duty bearing frame
- Double tapered roller bearings contribute further to precise rotor movement and longer seal life
- Body bolted to gearcase to maintain seal face contact, when removing cover and rotors
- Greased lubed bearings for positive lubrication to all bearings over entire speed, temperature and pressure range
- No bearing in product zone
- Rotor nuts designed for extended service without loosening



Typical product applications

Canning

- Tomato ingredient
- Vegetables, diced, slurries
- Pet foods



Chemical/Industrial

- Solvents
- Fuels
- Oils & Lubricants
- Paper pulp slurry
- Sludges



Installation/Maintenance Flexibility

- Bi-directional flow. No flow direction specification needed.
- 4-Way mounting of gear case, including vertical alignment of ports.
- Side mount gearcase mounting feet available.
- Waukesha single, double or commercially available mechanical seals.
- External shimming simplifies internal clearance adjustments.
- Upper or lower shaft position.
- Bearing lube fittings located on both sides of gearcase.
- Labyrinth seal bearing protection available.

TIME-TESTED WAUKESHA CHERRY-BURRELL ROTARY PUMP; EXTERNAL CIRCUMFERENTIAL PISTON (ECP) OPERATING PRINCIPLE

In the Waukesha design, arc-shaped "pistons" (rotor wings) travel in annular-shaped cylinders machined in the pump body; the resulting long sealing path reduces slippage and produces a smooth flow of product without destructive pulses or pressure peaks and without valves or complex parts. Accurate and uniform displacement volume provides metering capabilities and good flow control.

EXCLUSIVE WAUKESHA DESIGN FEATURES

For Low Viscosity Fluids, Rotors, made of exclusive Waukesha "88" alloy, can be run with close clearance to the 316 stainless steel fluid head, without galling or seizing should inadvertent pressure surges cause contact. The close clearances combined with the rotor geometry, which gives a long sealing path between the pump inlet and outlet, means low slip operation. As a result, you achieve: high efficiency, good priming ability, metering capability and good flow control.

For High Viscosity Fluids, the large fluid cavities of the rotors, plus the large, easy entry anti-cavitation ports allow efficient pumping of high viscosity fluids, slurries or even liquids with large chunks or particles.

For Non-Lubricating and Abrasive Fluids, the unique Waukesha design has no bearings in the fluid being pumped, no sliding or rolling contact and no rotor-to-rotor contact. This produces MAXIMUM SERVICE LIFE even under severe operating conditions.

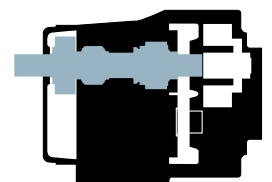
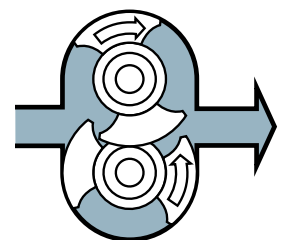
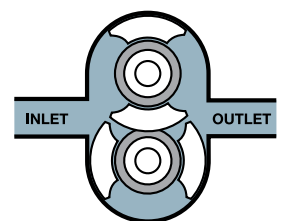
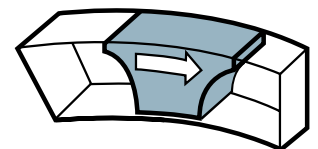

Performance and Long Life Through Engineering.

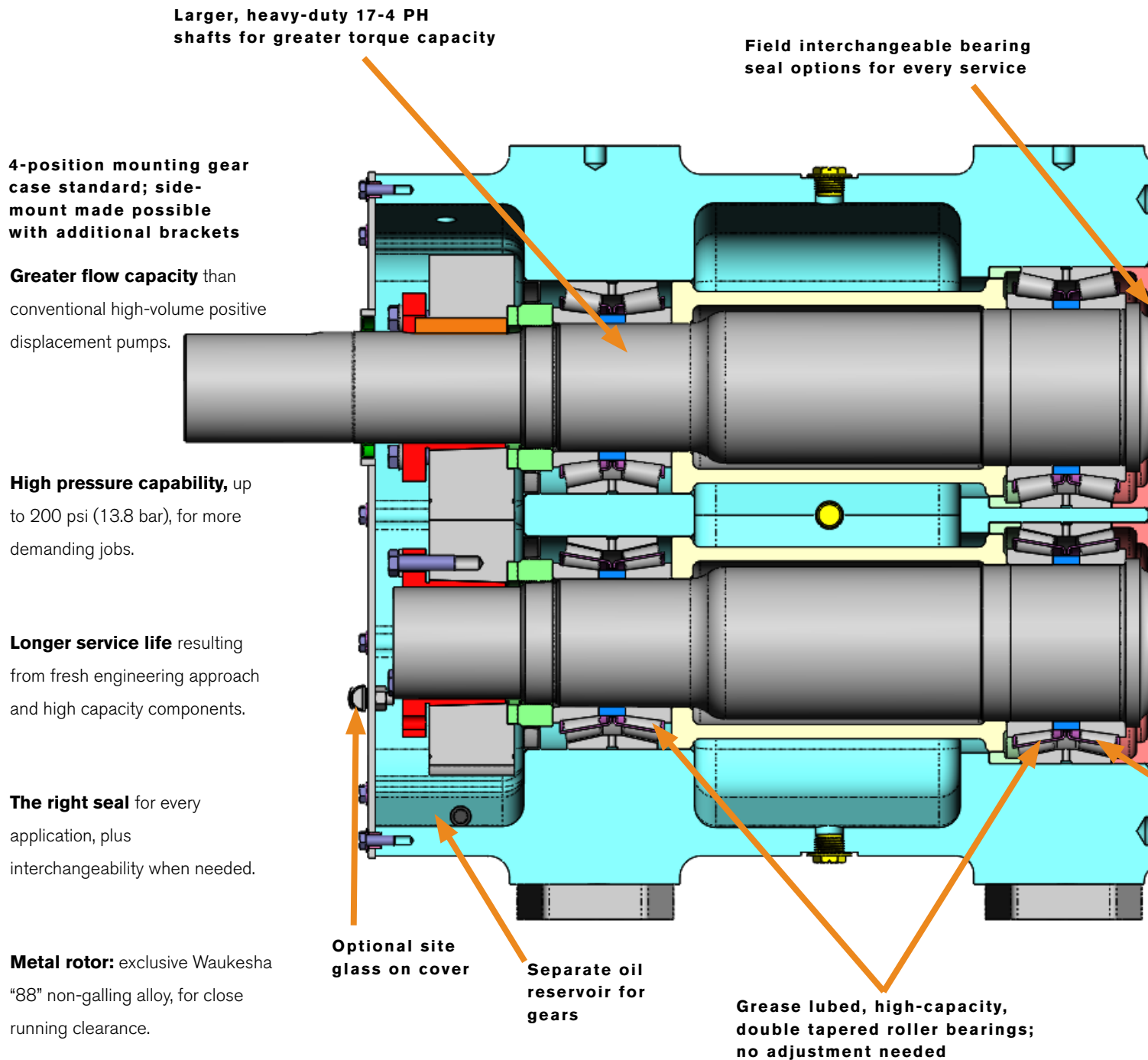

Seal Options

Single Inner Mechanical Seal

Silicone carbide-to-silicone carbide faces standard.

Single Outer Mechanical Seal

Carbon-to-silicone carbide faces standard.

Double Mechanical Seal

Used with flushing fluid to cool, lubricate, flush away residue. Best arrangement for severe service. Combines above single inner and outer seals.

Cartridge Seal

Consult factory.

Elastomer choices for "o" rings:

- Viton
- EPDM
- Silicone

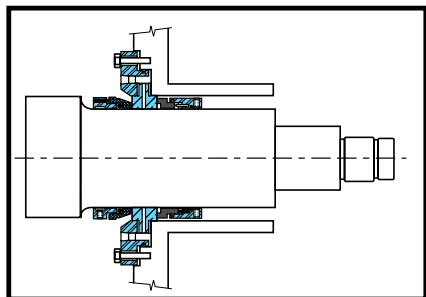
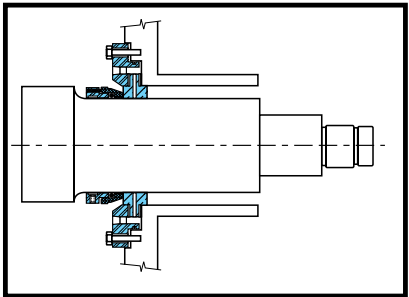
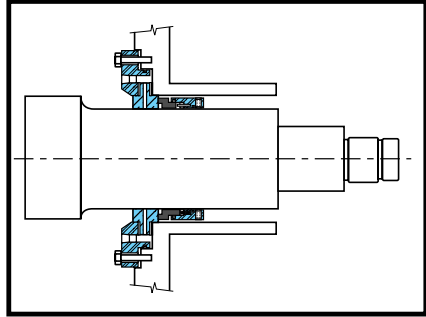
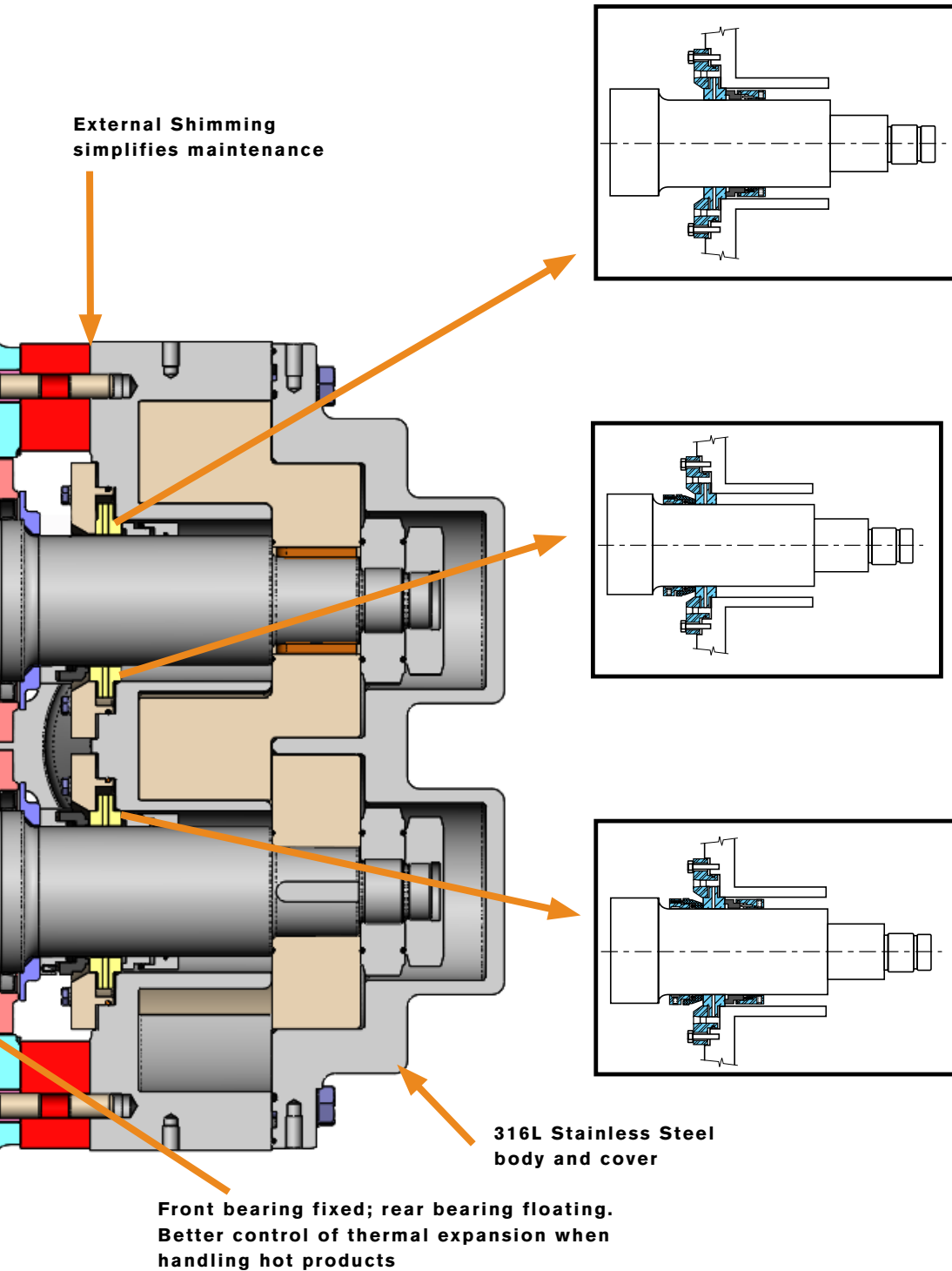

External Shimming
simplifies maintenance

316L Stainless Steel
body and cover

Front bearing fixed; rear bearing floating.
Better control of thermal expansion when
handling hot products

PRODUCT DIMENSIONS

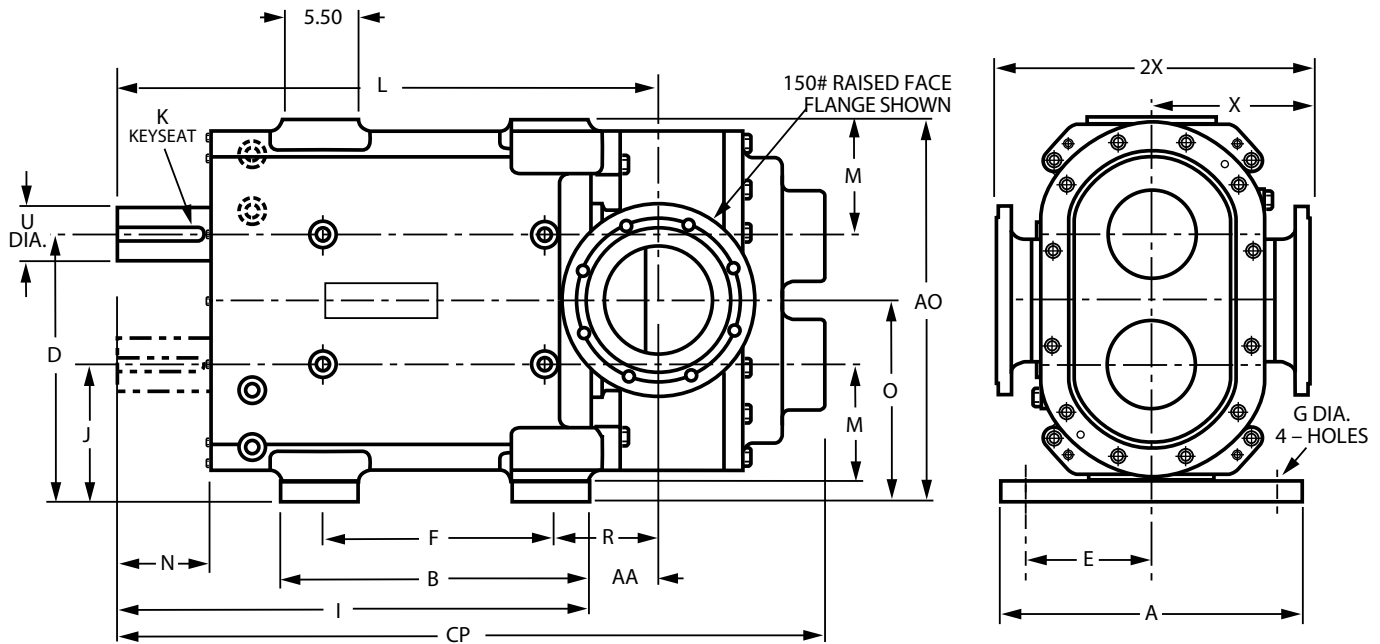

MODEL	IN/ mm	A	AA	AO	B	CP	D	E	F	G	I	J
420-UHC 423-UHC	IN	21.00	5.60	27.25	22.00	49.60	18.75	9.00	16.50	1.06	33.60	9.75
	mm	533.4	142.7	692.2	558.8	1259.8	476.2	228.6	419.1	26.92	853.4	247.6
520-UHC 523-UHC	IN	21.00	5.95	27.25	22.00	51.47	18.75	9.00	16.50	1.06	33.60	9.75
	mm	533.4	151.1	692.2	558.8	1307.3	476.2	228.6	419.1	26.92	853.4	247.6

MODEL	IN/ mm	K	L	M	N	O	R	U	X	2X	FLANGE SIZE
420-UHC 423-UHC	IN	1.00	39.19	8.50	6.04	14.25	8.35	3.875	11.25	22.50	ANSI 6"
	mm	25.4	995.4	215.9	153.4	362	212.1	98.42	285.7	571.5	
520-UHC 523-UHC	IN	1.00	39.55	8.50	6.04	14.25	8.70	3.875	11.25	22.50	ANSI 8"
	mm	25.4	1004.6	215.9	153.4	362	221.0	98.42	285.7	571.5	

PRODUCT SPECIFICATIONS

MODEL	DISPLACEMENT PER REVOLUTION	NOMINAL CAPACITY TO	INLET/OUTLET	PRESSURE RANGE UP TO*	MAXIMUM RPM	TEMP. RANGE
420-UHC 423-UHC	1.619 gal. (6.13 Liter)	648 GPM (147 m ³ /hr)	6" 150 lb. RF	200 psi (13.8 bar)	400	-40°F (-40°C) to 300°F (149°C)
520-UHC 523-UHC	2.375 gal. (8.99 Liter)	830 GPM (187 m ³ /hr)	8" 150 lb. RF	150 psi (10.3 bar)	350	

*Contact application engineering for higher pressure applications.

OPTIONS AND ACCESSORIES

Ports

150 LB RF Flange Standard
 300 LB RF Flange Available

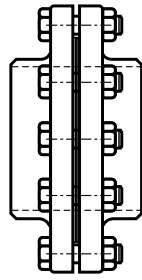

Rotors

Alloy 88 Standard.
316 SS Optional.

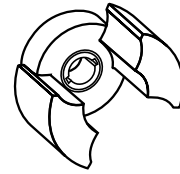

Rotor clearance standard for most applications up to 200°F (93°C).

Hot clearance rotor option for applications up to 300° F (149°C).
 Other special clearances available.

O-Rings

Elastomer Choices for “O” Rings:

- Viton
- EPDM
- Silicone

Aseptic Models

Double barriers or seals protect at every opening to the pump chamber. Live steam or a sterile fluid is circulated between these double seals at the ports, in the cover and at the shaft seals form an impenetrable barrier to contaminants.

Seals

Mechanical seal material options:

- Silicone Carbide
- Carbon

Consult factory for cartridge or other seal options.

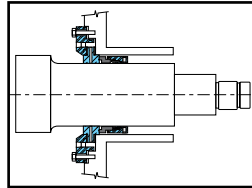

Single Mechanical Seal, Inside

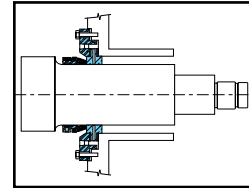

Single Mechanical Seal, Outside

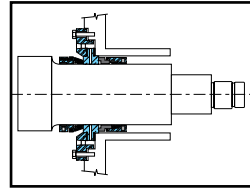

Double Mechanical Seal

Shaft Position

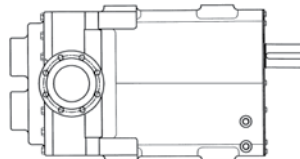

Top Shaft Position, Standard

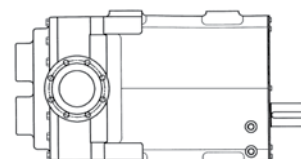

Lower Shaft Position, Optional

Optional Mounting

Field Interchangeable

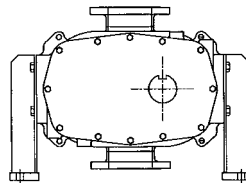

Standard Left Hand Shaft Position

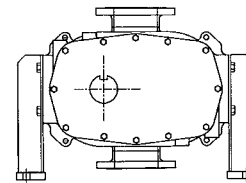

Optional Right Hand Shaft Position

Bases and Drives

Optional Side Mount Gear Case for vertical fluid entry available.

- Fabricated or Stainless Steel Bases
- Direct connected Gear Motors
- Mechanical and Electronic Variable Speed Drives

Universal 420/520 High Capacity

**ROTARY POSITIVE
DISPLACEMENT PUMPS**

SPX FLOW

Based in Charlotte, North Carolina, SPX FLOW, Inc. (NYSE: FLOW) is a multi-industry manufacturing leader. For more information, please visit www.spxflow.com

SPX FLOW

611 Sugar Creek Road

Delavan, WI 53115

P: (262) 728-1900 or (800) 252-5200

F: (262) 728-4904 or (800) 252-5012

E: wcb@spxflow.com

SPX FLOW, Inc. reserves the right to incorporate our latest design and material changes without notice or obligation.

Design features, materials of construction and dimensional data, as described in this bulletin, are provided for your information only and should not be relied upon unless confirmed in writing. Please contact your local sales representative for product availability in your region. For more information visit www.spxflow.com.

The green "y" and "x" are trademarks of SPX FLOW, Inc.

ISSUED 04/2016 FH-1725

COPYRIGHT © 2016 SPX FLOW, Inc.