

Manual Valves



Check Valves

45 SPRING CHECK VALVES

- Waukesha Cherry-Burrell brand W45 Check Valves are 'wafer-style', where product flow pushes the valve disc away from the seat. In the absence of forward flow pressure, the electropolished spring returns the disc and holds it closed against the seat. Back flow pressure also pushes the disc into the closed position.
- Two available seal options: o-ring or Tri Ring; in the disc OD provides tight closure while metal-to-metal contact between the disc and seat allows for long-lasting, durable operation.
- Machined from 316L stainless steel bar with all polished surfaces < 32 Ra, the W45 Check Valve has smooth internal surfaces for superior cleaning.
- When free-draining is required, the W45 must be vertically mounted.



W45 Spring Check Valve

45 SPRING CHECK VALVE DIMENSIONS

| SIZE INCHES (mm) | A | CRACKING PRESURE | |
|------------------|-------------|-------------------|-------------------|
| | | O-RING SEAT | TRI RING SEAT |
| 1.0 (25.4) | 4.0 (101.6) | 1.0 psi (.07 bar) | 4.9 psi (.34 bar) |
| 1.5 (38.1) | 4.0 (101.6) | 1.0 psi (.07 bar) | 4.9 psi (.34 bar) |
| 2.0 (50.8) | 4.0 (101.6) | 1.4 psi (.10 bar) | 5.9 psi (.41 bar) |
| 2.5 (63.5) | 5.0 (127) | 1.0 psi (.07 bar) | 5.7 psi (.40 bar) |
| 3.0 (76.2) | 5.5 (139.7) | 1.2 (.08 bar) | 5.3 (.37 bar) |
| 4.0 (101.6) | 6.0 (152.4) | 1.0 (.07 bar) | 4.0 (.28 bar) |

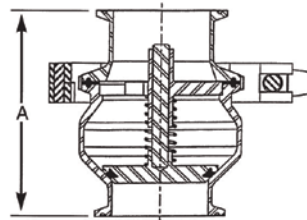

Heavy compression closure option for high velocities.

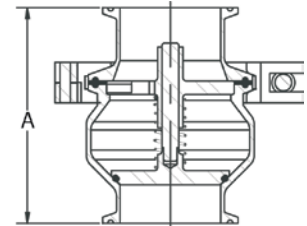

O-ring seat with light spring for low flow resistance.

FEATURES:

- Positive o-ring Seal and metal-to-metal seating for robust, "soft seat" closure
- Limited Stroke to Prevent Over-compression: Improves Spring Life, Reduces Stem Wear, Improves Cleanability
- CIP capable, 3-A Design in 1"-4" (25 mm - 102 mm) sizes
- Machined from bar 316LSS body construction with sanitary polish
- Electro-polished spring for ease in cleaning and longer life
- Spider-guided with long guide-bearing area

OPTIONS:

- Choice of gasket materials: EPDM or FKM
- Connections: S-Line or Buttweld
- Connection sizes: 1.5" (38 mm), 2" (51 mm), 2.5" (64 mm), 3" (76 mm), and 4" (102 mm)
- Tri Ring seal option for high velocity flow applications (greater than 5ft/s (1.5m/s) or sticky/adhesive type product)

APPLICATIONS:

- Stops or checks reverse flow in a pipeline

Check Valves

45BY BALL CHECK VALVES

- Waukesha Cherry-Burrell brand Ball Check Valves have a 316L stainless steel body with a curved offset ball trap. Product flow pushes the ball up into the trap and out of the product stream for full diameter flow.
- This valve is well suited to applications where there is pulsing flow and should not be used for sticky, adhesive products, or those with excessive viscosities where the ball can be held in the offset tube.
- Vertical installations are preferred where product must flow bottom to top to gravity seat the ball.
- For horizontal installations, the curved offset must be upright and perpendicular to the plane of the pipeline for free-draining and proper ball seating. A minimum liquid pressure is required to seal ball.
- Waukesha Cherry-Burrell brand Ball Check Valves use larger diameter balls for the tube size than those used by competitors; eliminating the possibility of jamming the ball in the product tube, which can otherwise occur when subjected to high back pressure or hydraulic shock.
- Choose the ball material to suit various applications; either (Buna-N, Viton, or EPDM) or solid nylon.



W45BYMP Ball Check Valve

45BY BALL CHECK VALVE DIMENSIONS

| SIZE INCHES (mm) | A |
|------------------|---------------|
| 1.5 (38.1) | 8.62 (218.9) |
| 2.0 (50.8) | 10.19 (258.8) |
| 2.5 (63.5) | 11.50 (292.1) |
| 3.0 (76.2) | 12.37 (314.2) |

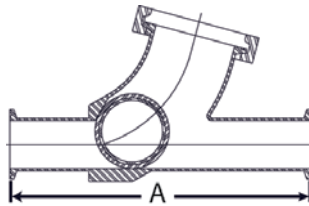

45BY AIR BLOW OPTION

Ball check with 62 air blow check is used to isolate upstream equipment for air-recover of downstream product. A combination of two manual valves can be sold as an assembly.

NOTE: Air Blow valve size is larger than ball check size

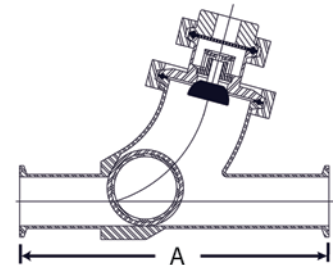

FEATURES:

- CIP capable, fully drainable design
- Meets 3-A Standards
- 316LSS body material
- Sanitary polish
- Non-jam, large diameter balls
- Air-blow option

OPTIONS:

- Choice of ball materials: solid nylon or rubber covered (Buna-N, EPDM, or FKM)
- Connections: S-Line, I-Line (male or female), Q-Line, Bevel seat, Buttweld, SMS, or DIN
- Connections: S-Line, I-Line, Q-Line, Bevel seat, or Butt weld

APPLICATIONS:

- Stops or checks reverse flow in a pipeline
- Air blow for product recovery

Check Valves

62B AIR BLOW CHECK VALVES

- Waukesha Cherry-Burrell brand 62B Air Blow Check Valves are 'plug-style', where air pressure pushes the bonded rubber plug away from the seat. In the absence of air pressure, the spring returns the plug and holds it closed against the seat.
- For 3-A applications the Waukesha Cherry-Burrell brand 62B Air Blow Check Valve must be used with the incorporated filter disc and suitable air to be in contact with product.
- Air usage: estimated air volume usage will depend upon the pipeline vessel to be evacuated. The Waukesha Cherry-Burrell brand 62B is rated up to 1600 Ft³/Hr. (488 m³/Hr.) air flow.



62B Air Blow Check Valve

NPT ADAPTER STYLE DIMENSIONS

NPT Air Inlet

Available in sizes 1.5" (38 mm), 2" (51 mm), 2.5" (64 mm), 3" (76 mm), 3.5" (89 mm), 4" (102 mm), 4.5" (114 mm) with S-Line, Male I-Line, and Q-Line product connections.

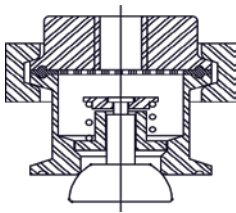

HOSE ADAPTER STYLE

Hose Barb Air Inlet

Available in sizes 1.5" (38 mm), 2" (51 mm), 2.5" (64 mm), 3" (76 mm), 3.5" (89 mm), 4" (102 mm), 4.5" (114 mm) with S-Line, Male I-Line, and Q-Line product connections.

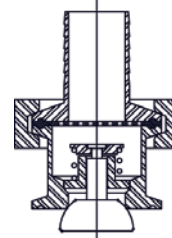

FEATURES:

- Fail-safe operation: spring-loaded plug design prevents back flow of product or CIP solution by a simple air-to-open, spring-to-close design
- Meets 3-A standards with 316L SS product contact surfaces
- Clamped body for easy assembly and disassembly
- Bonded Viton plug for effective, robust sealing
- 40 Micron air filter disc and Bun gasketed back-up screen for incoming
- Conforms to 3-A standard practice for applications requiring final filtering of air prior to product contact
- 1.5" - 4.5" (38 mm - 114 mm) sizes air

OPTIONS:

- Product Connections: S-Line, I-Line, and Q-Line
- Air Connections: 0.375" (9.5 mm), 0.5" (12.7 mm), and 0.75" (19 mm) NPT or OD hose barb
- Ball-Check / Air-Blow Valve assembly

APPLICATIONS:

- Spring-loaded plug-style check for air-entry into product pipelines
- Evacuation of process pipelines for product recovery and/or drainage
- Air agitation of product in pipelines, tanks, and other equipment
- Air drying of process lines and equipment for corrosion resistance/formation of protective oxide films

Check Valves

45HMP HORIZONTAL CHECK VALVE

- Waukesha Cherry-Burrell brand 45HMP Check Valves are 'wafer-style,' where product flow pushes the valve disc away from the seat. In the absence of forward flow pressure, the electropolished spring returns the disc and holds it closed against the seat. Back flow pressure also pushes the disc into the closed position.
- Eccentric design allows free draining when mounted in the horizontal position.



45HMP Horizontal Check Valve

45HMP HORIZONTAL CHECK VALVE DIMENSIONS*

| SIZE INCHES (mm) | A | B |
|------------------|--------------|-------------|
| 1.0 (25.4) | 5.12 (130) | 0.5 (12.7) |
| 1.5 (38.1) | 5.12 (130) | 0.5 (12.7) |
| 2.0 (50.8) | 5.06 (128.5) | 0.5 (12.7) |
| 2.5 (63.5) | 6.27 (159.3) | 0.75 (19.1) |
| 3.0 (76.2) | 6.44 (163.6) | 0.75 (19.1) |

*Dimensions shown are for S-Line connection only, for other types of connection dimensions contact factory.

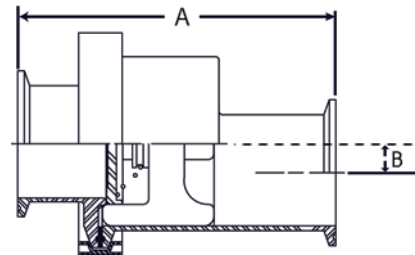

FEATURES:

- Eccentric body construction for free draining in the horizontal position
- 316LSS body construction with sanitary polish
- CIP capable

OPTIONS:

- Choice of gasket materials: Buna, EPDM or FKM
- Connections: S-Line, I-Line, Q-Line, Bevel Seat or Butt weld
- Connection sizes: 1.5" (38 mm), 2" (51 mm), 2.5" (64 mm), 3" (76 mm)

APPLICATIONS:

- Stops or checks reverse flow in a pipeline

Relief Valves

60R SERIES RELIEF VALVES

Versatile, manually-adjustable Relief Valve for pipeline protection.

Durable, compact, and easy to operate.

Features and Options:

- Manually adjustable, lockable cap for setting the relief pressure
- 316LSS sanitary construction with No. 4 internal polish
- Choice of spring pressures: 50 lb. (22.6 kg.), 100 lb. (45.3 kg.), or 300 lb. (136 kg.)
- Choice of body styles: single outlet 'T' style or cross body
- Connections: S-Line, Q-Line, Bevel Seat, or Buttweld
- Connection sizes: 1.5" (38 mm) or 2" (51 mm)
- This valve is a manually adjustable over-pressure device in which the product pushes against the plug of the valve stem. The stem is held in the closed position by the spring, which is adjusted in holding force by an external lockable cap.
- Each spring has a force range, dependent upon how much it is compressed. The more compression, the higher the pressure at which the valve will open.
- Choose the spring rating large enough to comfortably achieve the desired setting without compressing the spring down to the stack height. Tightening down the adjustable cap to the maximum pressure will limit the stroke of the valve.
- For cleaning, unload the valve by turning the cap and backing off the spring pressure.
- Choice of seats: PTFE o-ring or metal*

*NOTE: Metal seat option may not provide positive shut off of thin fluids



60R Relief Valve

60RMP RELIEF VALVE DIMENSIONS*

| SIZE INCHES (mm) | A | B |
|------------------|-------------|--------------|
| 1.5 (38.1) | 2.69 (68.3) | 8.06 (204.7) |
| 2.0 (50.8) | 3.03 (77) | 8.69 (220.7) |

*Dimensions shown are for S-Line connection only, for other types of connection dimensions contact factory.

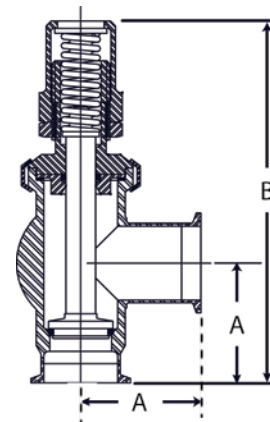

60RTTMP Relief Valve

Nomenclature De-Coder Chart

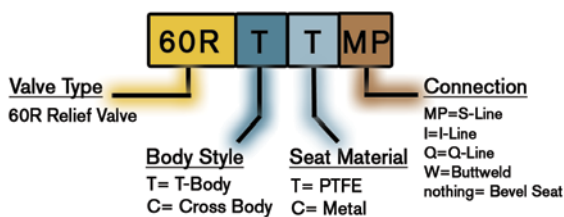

Relief Valves

16AMP-AR AIR RELIEF VALVES

- Compact and mounted in an S-Line Clamp Connection, the 16AMP-AR relieves air/vapor pressure and is most commonly used on the inlet of a Centrifugal Pump so when the pump is operating, the valve is sealed by the low suction pressure. However, when the pump is “air locked,” the pressure increases and the valve opens to let the air out of the system.
- Comprised of a Nylon poppet valve with a Buna o-ring seal, the valves can be supplied with 304SS, or 316LSS cap bodies.
- The valve is supplied in sizes 1.5" - 3" (38 mm - 76 mm).
- NOT FOR USE IN TANKS.

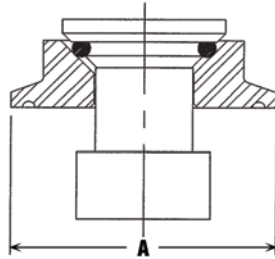

16AMP-AR Air Relief Valve

| SIZE INCHES (mm) | A |
|------------------|-------------|
| 1.5 (38.1) | 1.98 (50.3) |
| 2.0 (50.8) | 2.52 (64) |
| 2.5 (63.5) | 3.05 (77.5) |
| 3.0 (76.2) | 3.6 (91.4) |
| 4.0 (101.6) | 4.7 (119.4) |

16AMP-VB VENT VALVES

- Compact and mounted in an S-Line Clamp Connection, the 16AMP-VB Vacuum Breaker is used to prevent the formation of a vacuum in process lines.
- Comprised of a Nylon poppet valve with a Buna o-ring seal, the valves can be supplied with 304 Stainless Steel, or 316L Stainless Steel cap-like bodies.
- The valve is supplied in sizes 1.5" - 3" (38 mm - 76 mm).
- A common application is on HTST pasteurizers where the 16AMP-VB Valve is installed in the pasteurized side of the system. Raw (unpasteurized) milk must drain toward the raw supply and not in the pasteurized direction. The 16AMP-VB Vacuum Breaker is installed at the highest point in the piping, so that the product will drain in two directions from point of installation.
- NOT FOR USE IN TANKS.

| SIZE INCHES (mm) | A |
|------------------|-------------|
| 1.5 (38.1) | 1.98 (50.3) |
| 2.0 (50.8) | 2.52 (64) |
| 2.5 (63.5) | 3.05 (77.5) |
| 3.0 (76.2) | 3.6 (91.4) |
| 4.0 (101.6) | 4.7 (119.4) |

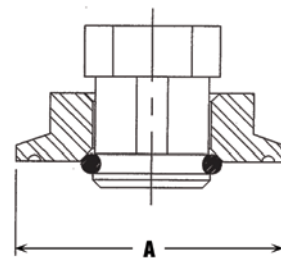

Relief Valves

40CF-AR AIR VENT VALVES

- For installation on pump suction lines, the 40CF-AR Air Vent Valve is designed to operate as a CIP return air relief, and operates against either vacuum or positive pressure. For proper operation, the valve should be mounted vertically.
- The 40CF-AR is available in 1.5"-4" (38 mm - 102 mm) sizes. S-Line connections are standard. Other connections are available on request.
- The 40CF-AR has a polypropylene ball that acts between the upper and lower machined seats. The valve body is machined stainless steel, either 304 or 316
- Buna gaskets or FKM.

Operation:

- In suction lines when the 40CF-AR valve is under vacuum, the ball is pulled down against the bottom seat and seals against air entry.
- When the vacuum is relieved in the process line, the ball loses its seal on the bottom seat, and any air in the process line is allowed to pass through the body of the valve and out of the system.
- When flooded with liquid, the floating nylon ball is held closed against the upper seat by pressure.
- Should the process line fill with air, the body of the valve will also fill with air. The ball falls from the top seat and the air is allowed to escape.
- NOT FOR USE IN TANKS.



40CF-AR AirVent Valve

Sample Valves

W30 SAMPLE VALVES

- Machined from solid bar 316L, the W30 Sample Valve can be used in a wide range of applications.
- The body and actuator arrangement are designed for high pressure applications.
- The Teflon® o-ring Seat is used for full shut off.
- The Optional SIP Flushing Port on the back side of the body is for high purity applications, where it is necessary to sterilize or flush the body of the valve prior to taking a sample. This valve is ideal for installation on high temperature process lines. Lined with a non-galling stainless steel alloy.
- Nylon Actuator Knob insulates against temperature.
- Available with "S" Clamp inlet from 0.5" - 2" (13 mm - 51 mm) size with outlets in "S" Clamp or hose barb.



K30SA SAMPLE VALVES

- The K30SA is a spring loaded sample valve that is commonly mounted on the door of a storage tank.
- Easy push operation
- The valve body is machined from 316L stainless steel and comes with "S" Clamp connection. The "S" Clamp is used to attach the valve to a mating ferrule which is permanently attached to the tank.
- The valve is spring hold closed and is opened by pushing the stem toward the tank against the spring force.



Sample Valve Dimensions

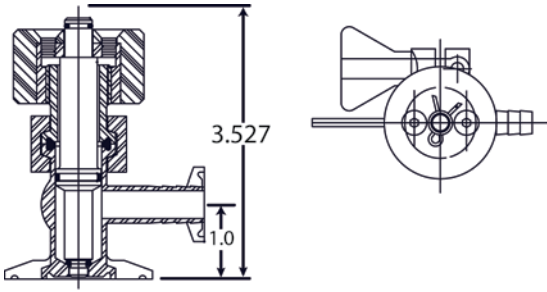

W30 Sample Valve

Material 316L

Surface Finish: 32 Ra or less

Body Styles Available:

- Standard Tee
- SIP 0.125" (0.32 mm) Tube OD

Seat Material PTFE

Inlet Connections Available:

- S-Line

Outlet Connections Available:

- S-Line (only available with .5" (13 mm) outlet size)
- Buttweld
- Hose Barb

| INLET SIZES | | OUTLET SIZES | |
|-------------|---------------|--------------|--------|
| INCHES | (mm) | INCHES | (mm) |
| 0.5 / 0.75 | (12.7 / 19.1) | 0.25 | (6.4) |
| 1.0 / 1.5 | (25.4 / 38.1) | 0.37 | (9.4) |
| 2.0 | (50.8) | 0.5 | (12.7) |
| 2.5 | (63.5) | | |
| 3.0 | (76.2) | | |

FEATURES:

- 316L SS Wetted Parts

Actuation

- W30 - Nylon Actuator Knob
- K30SA - push button with spring return

OPTIONS:

Inlet Connection:

- W30 - 0.5" (13 mm), 0.75" (19 mm), 1.5" (38 mm), or 2" (51 mm) S-Line
- K30SA - 1.5" (38 mm), or 2" (51 mm) S-Line

Outlet Connection:

- W30 - 0.25", 0.375" (10 mm), or 0.5" (13 mm), hose barb; or 0.5" (13 mm), S-Line

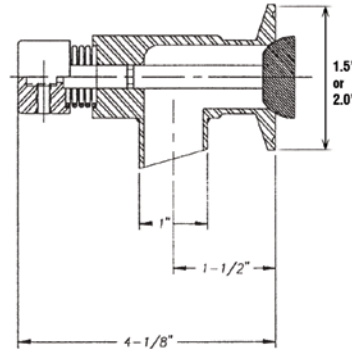

K30SA

Material 316L

Sizes Available: 1.5" (38 mm) or 2" (51 mm)

S-Line Inlet Standard

FKM Rubber Stem Plug

APPLICATIONS:

- Pressure: up to 100 psi (6.9 bar) service rating
- Temperature: up to 180°F (80°C) maximum
- CIP (Clean-In-Place) Cleaning

Page Intentionally Left Blank



Based in Charlotte, North Carolina, SPX FLOW, Inc. (NYSE: FLOW) is a multi-industry manufacturing leader. For more information, please visit www.spxflow.com

SPX FLOW

611 Sugar Creek Road

Delavan, WI 53115

P: (262) 728-1900 or (800) 252-5200

E: wcb@spxflow.com

SPX FLOW, Inc. reserves the right to incorporate our latest design and material changes without notice or obligation.

Design features, materials of construction and dimensional data, as described in this bulletin, are provided for your information only and should not be relied upon unless confirmed in writing. Please contact your local sales representative for product availability in your region. For more information visit www.spxflow.com.

The green "x" and "x" are trademarks of SPX FLOW, Inc.

WCB_Valves-Manual_FH-1858_BRO_US Version 01/2021

Identification Number: FH-1858-US

COPYRIGHT © 2021 SPX FLOW, Inc.